



# FH & FIH Series

(Interchange with Snap-Tite H & IH Series)



FH & FIH Series Quick Disconnect has provided years of reliable service on hydraulic/pneumatic applications in the handling of gases and fluids. The FH & FIH Series couplings are engineered to meet or exceeds MIL-C-51234. Options are available for static pressure hydraulic systems and also for pneumatic air tool use.

### Type:

- FH – Two Way Shut-Off and Straight-Thru
- FIH – One Way Shut-Off

### Interchangeability:

- FH Series interchanges with Snap-Tite “H” Series.
- FIH Series interchanges with Snap-Tite “IH” Series.
- Within each series, only sockets and plugs of the same size will couple together.

**Operation: Manual** – Socket sleeve must be manually retracted to connect and disconnect.

**Options:** Ball Lock (BL prefix) – Locks against accidental disconnect. To connect align ball with slot. After connection, rotate sleeve to lock. To disconnect, realign ball with slot and retract sleeve.

**Seal Compound:** Standard seals are Buna-N.

**Rated Pressure:** Rated Pressure as defined by ANSI/B93.2 – 1986, non-shock service.

### Socket Features:

- Latch Mechanism
  - Manual connect and disconnect
  - Steel sleeves are hardened to provide maximum service life
- Material and Finish
  - Machined from solid bar stock
  - Steel components are zinc plated
- Coupled Seal
- Valved units incorporate a Teflon back-up ring to with-stand dynamic impulse

### Plug Features:

- Machined from solid bar stock
- Steel plugs are hardened and zinc plated to provide heavy duty performance
- Flow - Large diameters provide for higher flow than other double shut-off quick disconnects
- Seals
  - Buna-N (Nitrile) seals are standard
  - Valve seals are crimped in place to maintain integrity during excessive flow conditions

Body Size	FH Series, Two Way		FH, Straight Thru		FIH Series, One Way
	Steel PSIG	Brass PSIG	Steel PSIG	Brass PSIG	Steel PSIG
1/4"	3250	2000	3000	3000	3000
3/8"	2250	1200	4000	3500	2250
1/2"	1800	1200	4000	2500	2000

### Performance:

Series “FH & FIH” - Valved or Non-Valved  
Test Fluid: Hydraulic Oil at 100°F

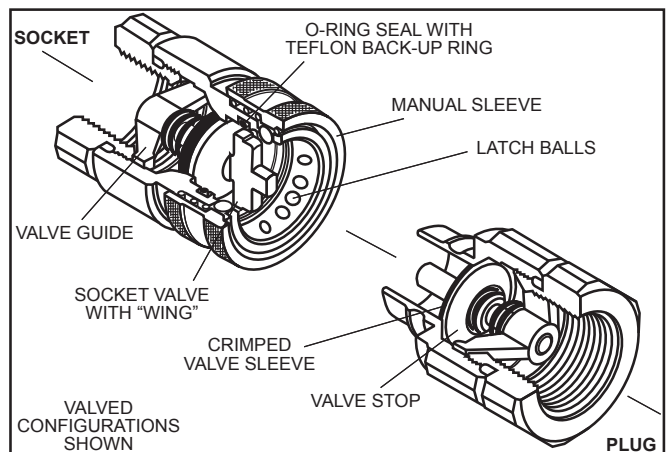
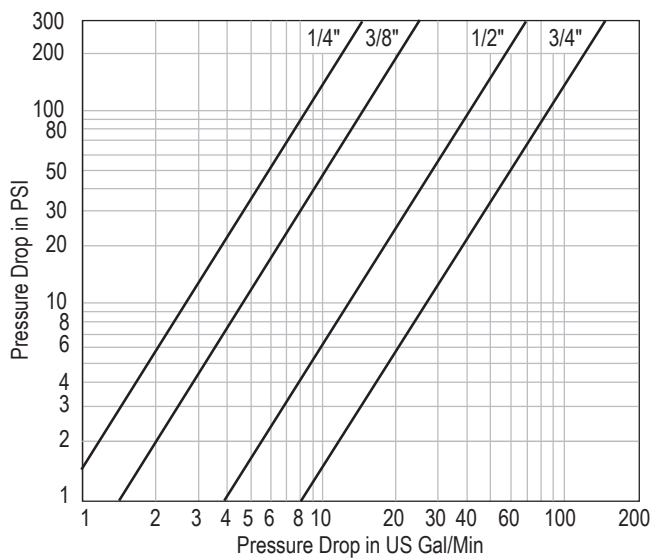

The FIH Series sockets & plugs are for pneumatic applications. The FIH sockets have a valve with 360° contact with plug.

■ Non-Standard Product □ Standard Product

Profile drawings available at [www.couplers.com](http://www.couplers.com)  
See page 144 for full size templates  
See page 130 - 131 for optional seal compounds



# FH & FIH Series

(Interchange with Snap-Tite H & IH Series)



**FOSTER**  
MANUFACTURING COMPANY

## FH Series, Two Way Valved Plugs

Female Thread		Part No.	FPT	Description
		FHP2F2	1/4"	Steel
		FHP2F2-101		Steel w/Viton Seal
		FHP2F2B		Brass
		FHP2F2B-101		Brass, w/Viton Seal
		FHP3F3	3/8"	Steel
		FHP3F3B		Brass
		FHP4F4	1/2"	Steel
		FHP4F4B		Brass

Male Thread		Part No.	MPT	Description
		FHP2M2	1/4"	Steel
		FHP2M2-103		Steel w/Ethylene Prop. Seal
		FHP2M2B		Brass
		FHP2M2B-103		Brass w/EPDM Seal
		FHP3M3	3/8"	Steel
		FHP3M3B		Brass
		FHP4M4	1/2"	Steel
		FHP4M4-101		Steel w/Viton Seal
FHP4M4B	Brass			

## FH Series, Two Way Valved Sockets

Female Thread		Part No.	FPT	Description
		FHS2F2	1/4"	Steel
		BLFHS2F2		Ball Lock, Steel
		FHS2F2-101		Steel w/Viton Seal
		FHS3F3	3/8"	Steel
		BLFHS3F3		Ball Lock, Steel
		FHS4F4	1/2"	Steel
		BLFHS4F4		Ball Lock, Steel
		FHS2F2B	1/4"	Brass
		BLFHS2F2B		Ball Lock, Brass
		FHS2F2B-101		Brass, w/Viton Seal
		FHS2F2B-103	Brass w/EPDM Seal	
		FHS3F3B	3/8"	Brass
		BLFHS3F3B		Ball Lock, Brass
FHS4F4B	1/2"	Brass		
BLFHS4F4B		Ball Lock, Brass		

Male Thread		Part No.	MPT	Description
		FHS2M2	1/4"	Steel
		FHS2M2-101		Steel w/Viton Seal
		BLFHS2M2		Ball Lock, Steel
		FHS3M3	3/8"	Steel
		BLFHS3M3		Ball Lock, Steel
		FHS4M4	1/2"	Steel
		FHS4M4-101		w/Viton Seal
		BLFHS4M4	Ball Lock, Steel	
		FHS2M2B	1/4"	Brass
		BLFHS2M2B		Ball Lock, Brass
		FHS3M3B		Brass
		BLFHS3M3B	Ball Lock, Brass	
		FHS4M4B	1/2"	Brass
BLFHS4M4B	Ball Lock, Brass			
FHS4M4B-103	Brass w/EPDM Seal			

## FIH Series, Unvalved Plugs (Use with both FI & FIH Sockets)

Female Thread		Part No.	FPT	Description
		FH21F	1/8"	Steel
		FH22F	1/4"	Steel
		FH22FB		Brass
		FH33F	3/8"	Steel
		FH33FB		Brass
		FH44F	1/2"	Steel
		FH44FB		Brass

Male Thread		Part No.	MPT	Description
		FH22M	1/4"	Steel
		FH22MB		Brass
		FH33M	3/8"	Steel
		FH33MB		Brass
		FH44M	1/2"	Steel
		FH44MB		Brass

## FIH Series, One Way Valved Sockets

Female Thread		Part No.	FPT	Description
		FIS2F2	1/4"	Steel
		BLFIS2F2		Ball Lock, Steel
		FIS3F3	3/8"	Steel
		BLFIS3F3		Ball Lock, Steel
		FIS4F4	1/2"	Steel
BLFIS4F4	Ball Lock, Steel			

Male Thread		Part No.	MPT	Description
		FIS2M2	1/4"	Steel
		BLFIS2M2		Ball Lock, Steel
		FIS3M3	3/8"	Steel
		BLFIS3M3		Ball Lock, Steel
		FIS4M4	1/2"	Steel
		BLFIS4M4		Ball Lock, Steel

## FH Series, Straight-Thru Sockets

Female Thread		Part No.	FPT	Description (no valve)
		FHS2	1/4"	Steel
		BLFHS2		Ball Lock, Steel
		FHS2B		Brass
		BLFHS2B	Ball Lock, Brass	
		FHS2B-101	Brass, w/Viton Seal	
		FHS3	3/8"	Steel
		BLFHS3		Ball Lock, Steel
		FHS3-101		Brass, w/Viton Seal
		FHS3B		Brass
		BLFHS3B	Ball Lock, Brass	
		FHS4	1/2"	Steel
		BLFHS4		Ball Lock, Steel
		FHS4B		Brass
BLFHS4B	Ball Lock, Brass			

Non-Standard Product     Standard Product

See page 144 for full size templates